













LANDO

220 1K

-  minimalny rozmiar szafki
minimal cabinet size
-  zlewozmywak odwracalny
reversible sink
-  zlewozmywak na równi z blatem
flushmount sink
-  montowany za pomocą silikonu / nie posiada zaczepów
silicone installation / no hooks necessary
-  wycięcie według wykrojnika
* wzór wykrojnika pliku DWG do pobrania na stronie www
cutting with sawing template
* cutting template as DWG file available on our website
-  w komplecie zestaw syfonowy automatyczny
provided with automatic siphone
-  możliwość podłączenia do zmywarki
possibility of dishwasher connection
-  możliwość montażu młynka
possibility of installing a waste disposer
-  dostępny w 12 kolorach
available in 12 colours
-  materiał
material **MAGRANIT® MATERIAL**
-  waga / weight : 4,2 kg

1 KOMORA
1 BOWL SINK

Index: **709 100 OXX**

XX - oznacza kolor zlewozmywaka
stands of sink colour

| DŁUGOŚĆ LENGTH | SZEROKOŚĆ WIDTH | WYSOKOŚĆ HEIGHT |
|-------------------|--------------------|--------------------|
| 220 | 420 | 137 |

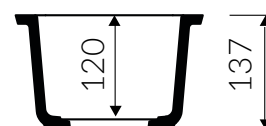
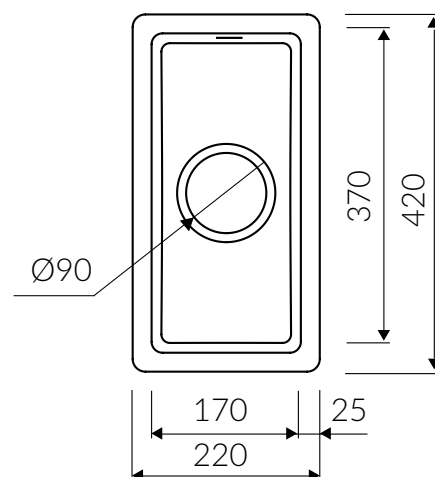

Wymiary zlewozmywaka mogą się różnić o 0,3%.
Dimensions of the kitchen sink may differ by 0.3 %.

