





OTAGO

500 1K

 minimalny rozmiar szafki
minimal cabinet size

 zlewozmywak wpuszczany w blat
inset sink

 z zaczepami
with hooks

 wycięcie według wykrojnika (wykrojnik w kartonie)
cutting with sawing template (template in the box)

 w komplecie zestaw syfonowy automatyczny
provided with automatic siphone

 możliwość podłączenia do zmywarki
possibility of dishwasher connection

 możliwość montażu młynka
possibility of installing a waste disposer

 dostępny w 12 kolorach
available in 12 colours

 materiał **MAGRANIT® MATERIAL**
material

 waga / weight : 8 kg

1 KOMORA
1 BOWL SINK

Index: **505 103 0XX**

XX - oznacza kolor zlewozmywaka
stands of sink colour

DŁUGOŚĆ LENGTH	SZEROKOŚĆ WIDTH	WYSOKOŚĆ HEIGHT
500	500	195

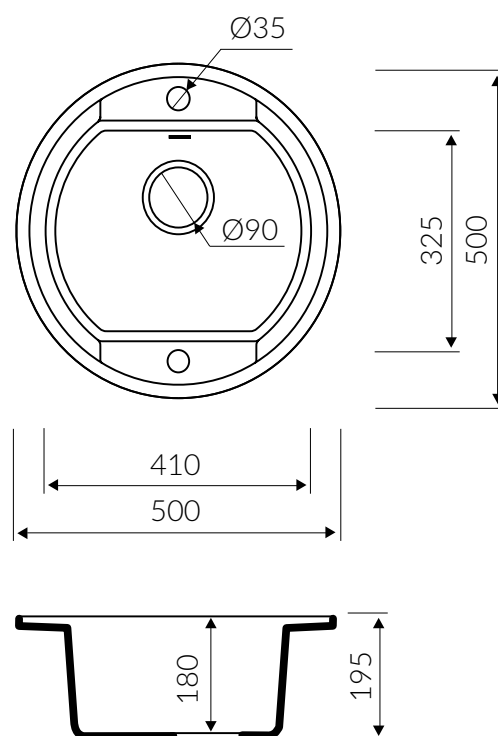

Wymiary zlewozmywaka mogą się różnić o 0,3%.
Dimensions of the kitchen sink may differ by 0.3 %.

PRODUKT KOMPATYBILNY Z / PRODUCT COMPATIBLE WITH:

KOSZYK / STEEL COLANDER

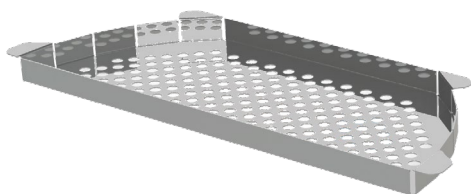

do pobrania / downloads
www.marmorin.pl

.3ds

.dwg

.dxf

JULY 2015
edition: 22.07.2015

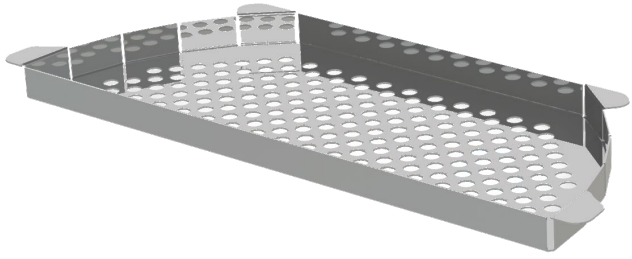

OTAGO

KOSZYK / STEEL COLANDER

Index: **KO 444**

DŁUGOŚĆ LENGTH	SZEROKOŚĆ WIDTH	WYSOKOŚĆ HEIGHT
432	163	21

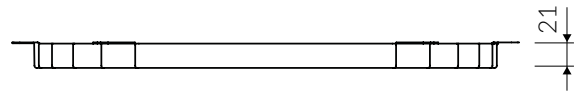
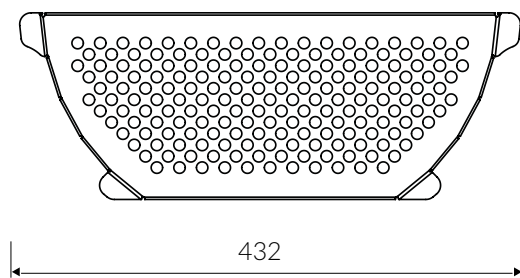

PRODUKT KOMPATYBILNY Z / PRODUCT COMPATIBLE WITH:

OTAGO 500 1K



OTAGO 780 1KO

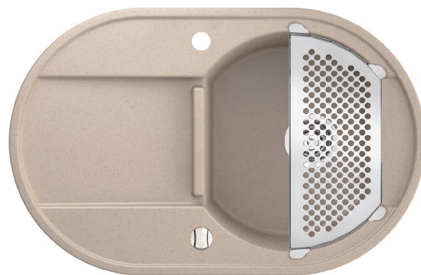

OTAGO 880 1,5KO

